

PROFILE GUIDE

Guide

OUTER FRAME

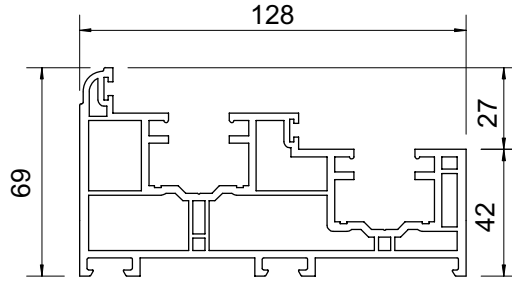

VS01 Outer Frame

CILLS

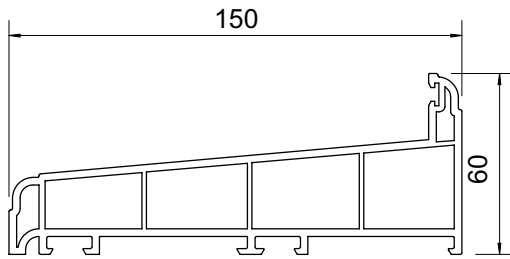

VS02 Cill

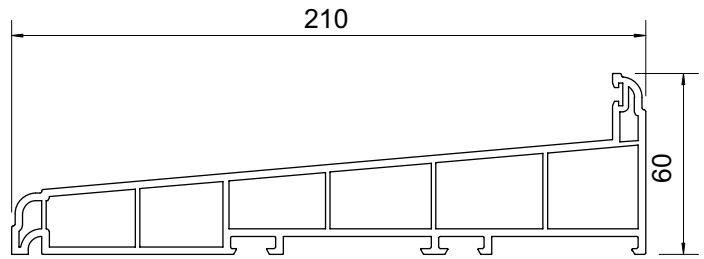

VS14 Extended Cill

SASHES

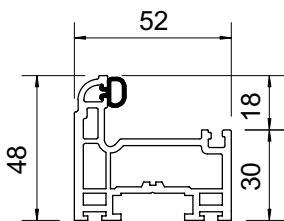

VS03 Small Sash

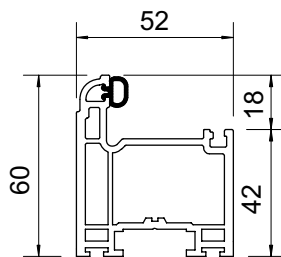

VS04 Standard Sash

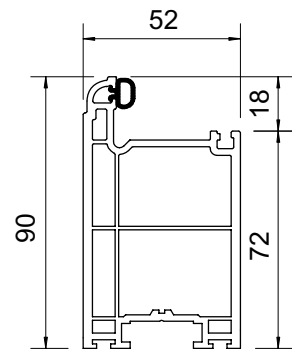

VS05 Deep Bottom Rail

INTERLOCKS & STOP

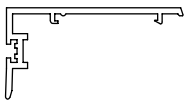

VS09 Interlock

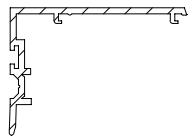

VSR9
Aluminium Interlock

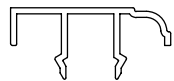

VS10 Sash Stop

BEADS & ANCILLARIES

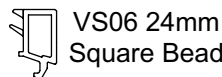

VS06 24mm
Square Bead



VS11 Small
Georgian Bar

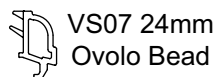

VS07 24mm
Ovolo Bead



VS12 Large
Georgian Bar



VS13
Woodgrain
Trim

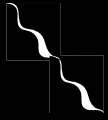

GENERAL ASSEMBLIES

Guide

STANDARD CONFIGURATION (VERTICAL SECTION)

TYPICAL VERTICAL SLIDING WINDOW

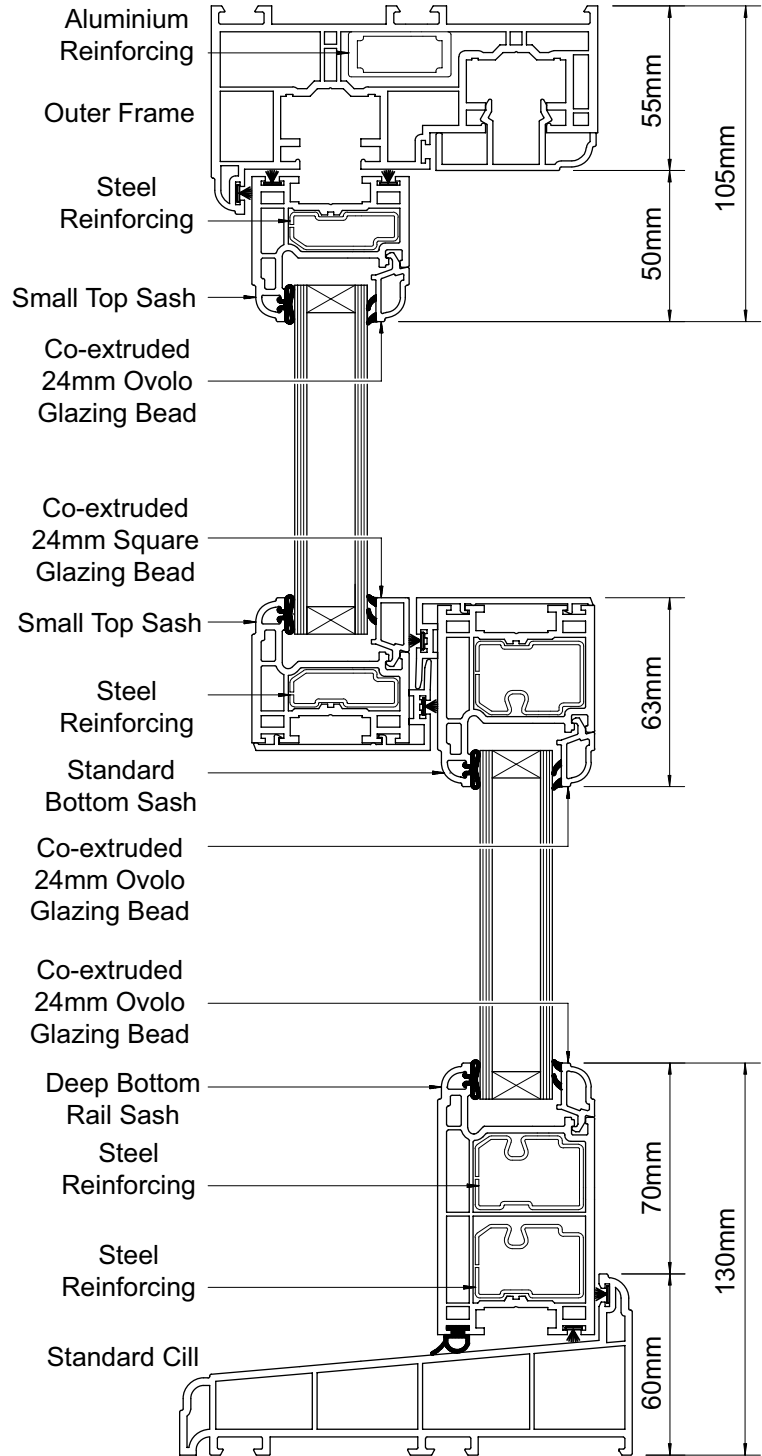
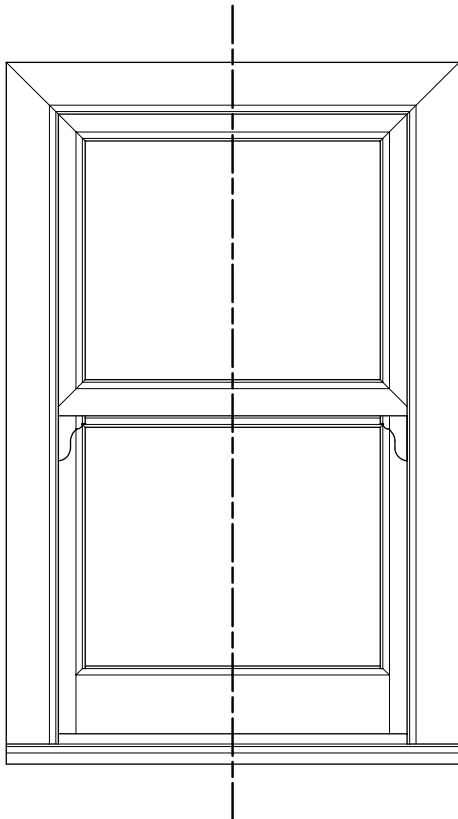

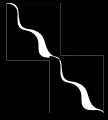

GENERAL ASSEMBLIES

Guide

STANDARD CONFIGURATION (HORIZONTAL SECTION)

TYPICAL VERTICAL SLIDING WINDOW

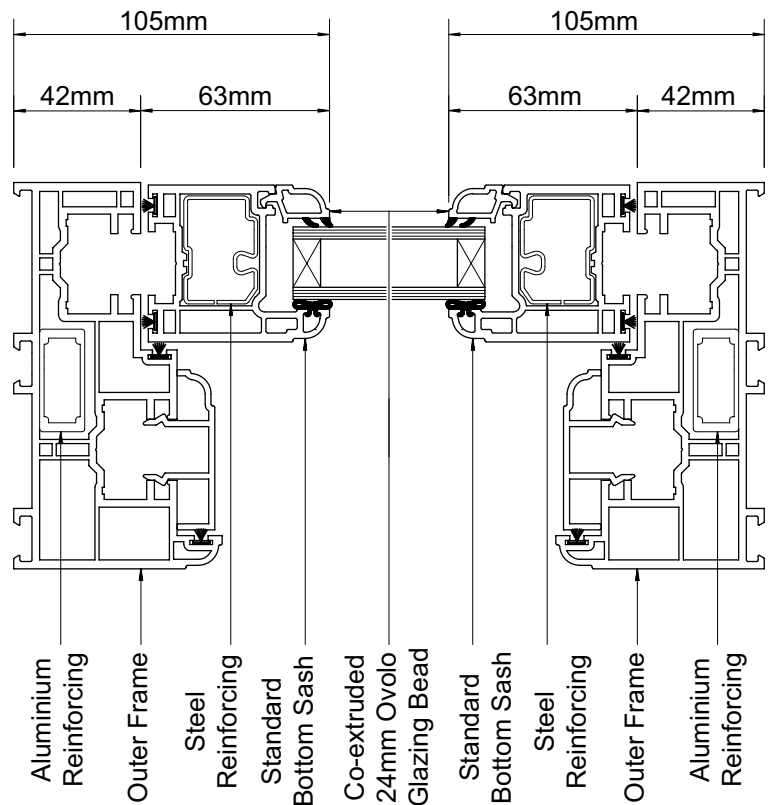
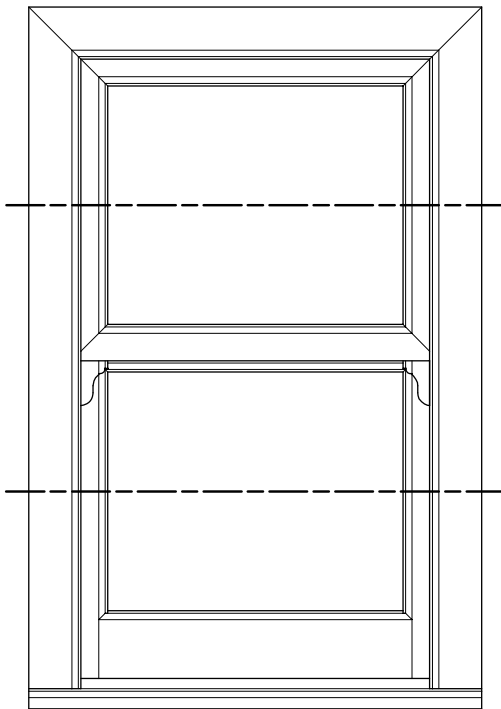
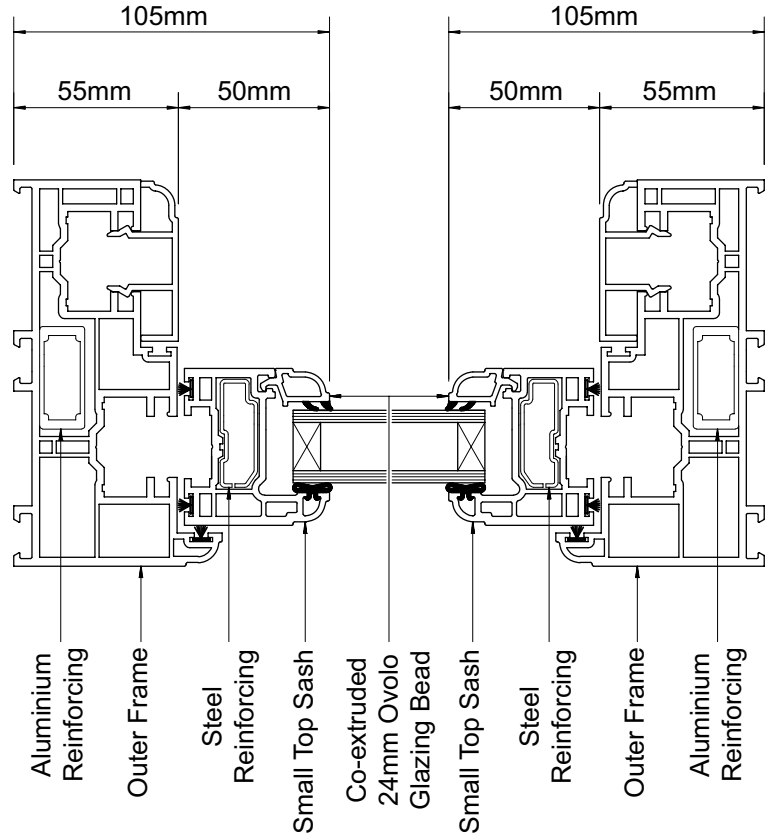
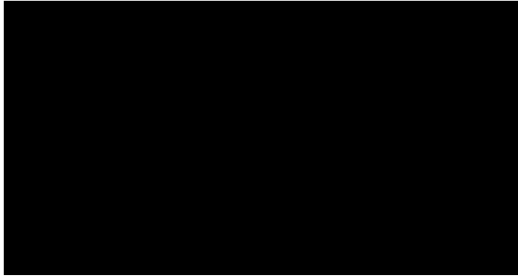

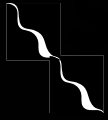

GENERAL ASSEMBLIES

Guide

HEAVY DUTY CONFIGURATION (VERTICAL SECTION)

TYPICAL VERTICAL SLIDING WINDOW

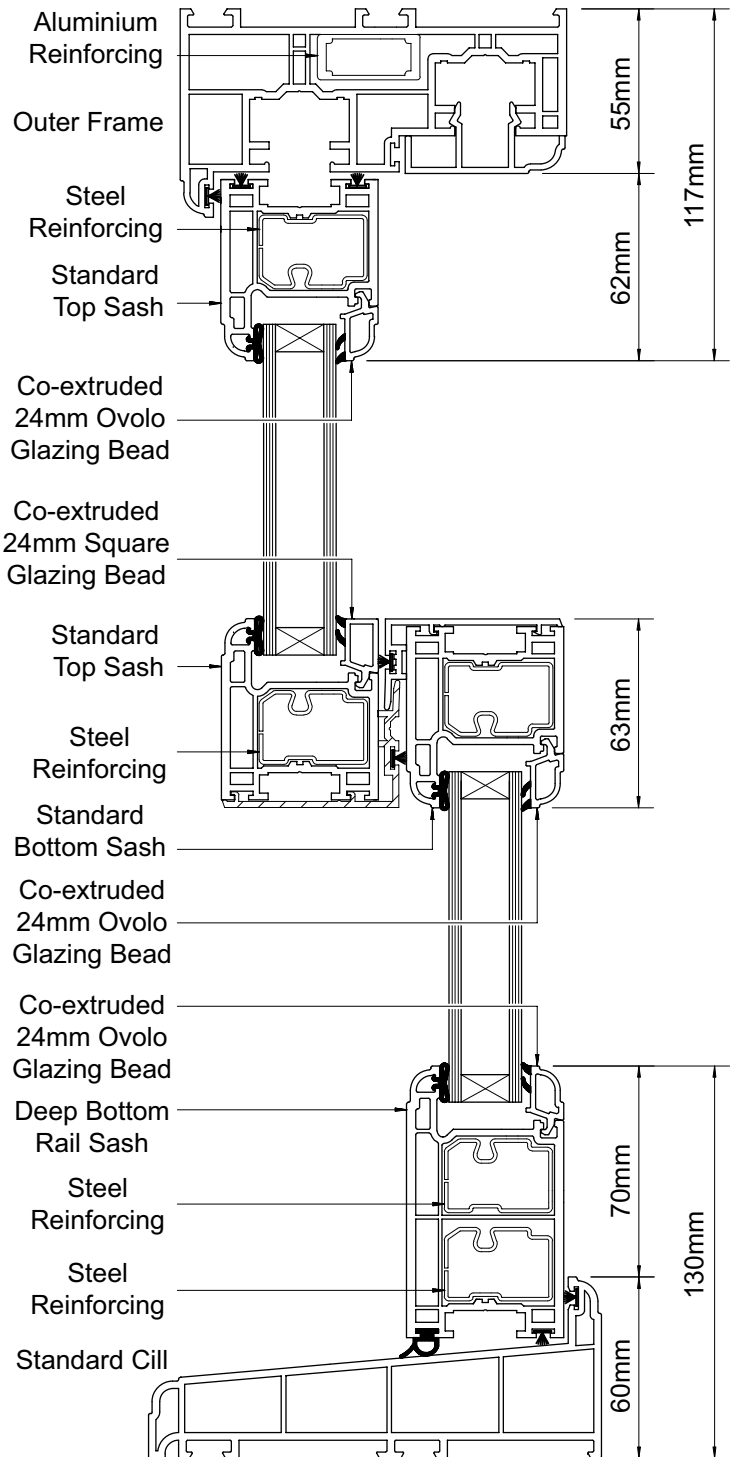
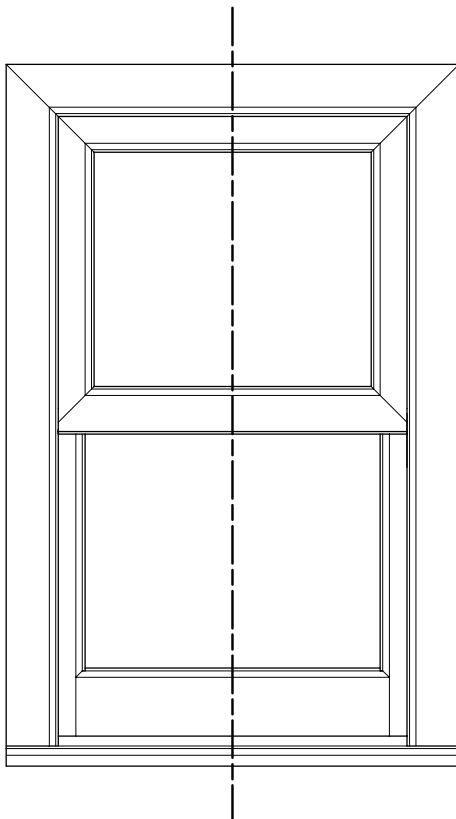

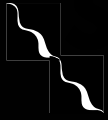

GENERAL ASSEMBLIES

Guide

HEAVY DUTY CONFIGURATION (HORIZONTAL SECTION)

TYPICAL VERTICAL SLIDING WINDOW

